

A SIMULATION STUDY TO EVALUATE THE APPROPRIATE DIMENSIONS OF A NEW AUTOMATED LOG SORTING AND STORING TECHNOLOGY IN THE WOOD PROCESSING INDUSTRY

Martin Pernkopf
Manfred Gronalt

Institute for Production and Logistics
University of Natural Resources and Life Sciences, Vienna
Feistmantelstrasse 4
1180 Vienna, AUSTRIA

ABSTRACT

Most common sawmill log yards are operated by wheel loaders or log stackers. As the operational costs of this form of transportation are quite high, new technologies might be advantageous. This study assesses the feasibility and the requirements for a technology to allow a high degree of automation of the log yard operations using automated storage components (ASCs). To find a reasonable size of an automated log yard for real-life applications, data from a softwood sawmill's log yard was analyzed and a simulation model was built. The results of the simulation study enable an educated assessment of the required dimension of the automated log storage for different scenarios.

1 INTRODUCTION

The sawing industry is an industry sector which requires a lot of transportation. Upstream the supply chain the logs have to be transported from the forests to the industry. Downstream the finished or semi-finished products have to be delivered to the customers or transported to further processing. Both transports cause high costs and therefore high efforts are made to reduce them.

Additionally, there is the necessity for considerable amounts of in-plant transport to provide logs for the actual sawing process. This intra-logistical process includes bringing all logs to the sorting station where they are sorted and ejected in different sorting boxes. Due to different quality and diameters a medium size sawmill has about 140 roundwood assortments. From the sorting boxes the logs are transported to the assigned storage areas. This transport is usually done by manually driven wheel loaders or log stackers. Before the logs can be cut they have to be transported from the storage area to the saw. A set of different transport devices is used at the log yard for sorting, stacking and transporting. As that transportation is quite expensive but considered inevitable, sawmills try to reduce the transport distances in order to reduce costs.

A new approach is to replace a main part of the intra-logistical transports through automating the log yard by installing automated storage components (ASC). These ASCs are automatically filled and emptied by conveyors. The automated log yard functions as a buffer storage between the sorting station and the sawing process. As it has to store all logs coming from the sorting station, the automated log yard has to be capable of stacking the logs stably. Figure 1 gives an overview of the concept of a log yard operated conventionally with wheel loaders and log stackers and an overview of the automated log yard observed in this study. Beaudoin, LeBel, and Soussi (2012) describe the typical processes at a loader-operated log yard. Rathke, Huka, and Gronalt (2013) give an example of another type of log yard operated by a manually driven crane.

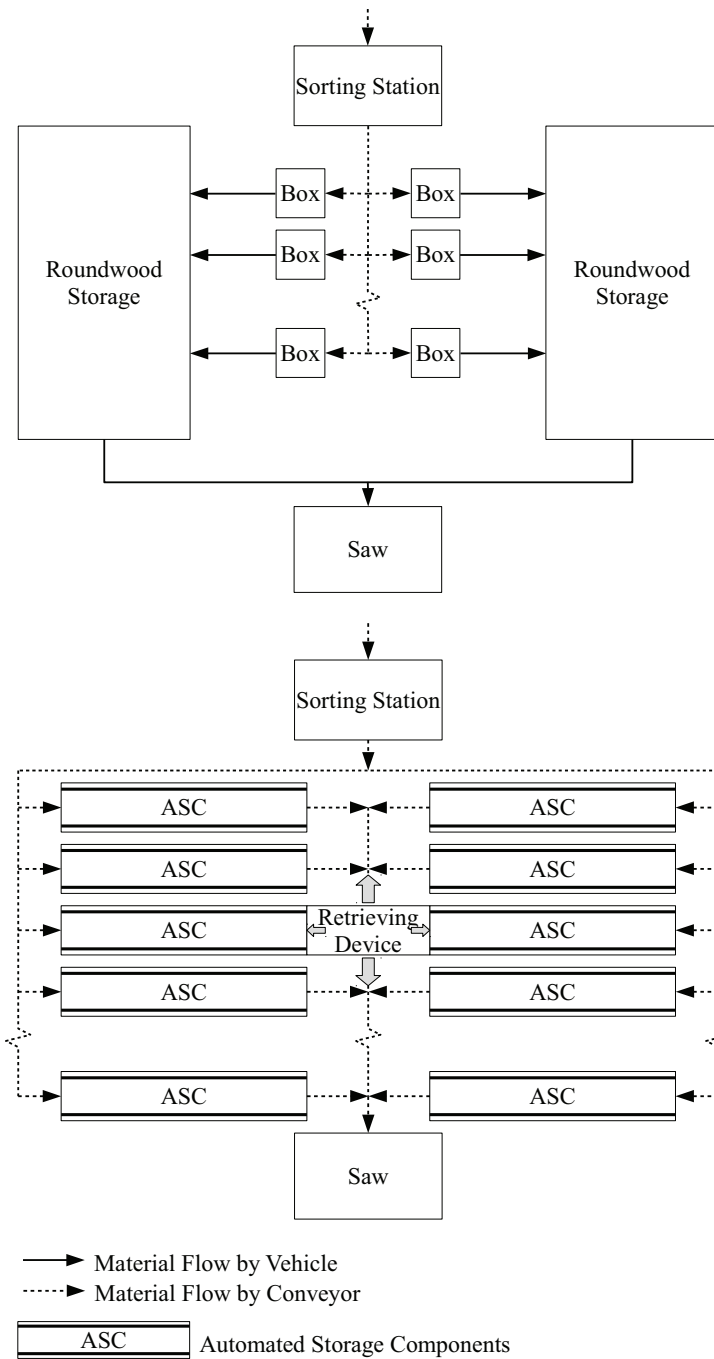

Figure 1: An overview of a common log yard (above) and the automated log yard (below) using automated storage components (ASCs).

The general idea of automating storages is quite common in other industries and several models for designing and evaluating automated storages have been developed (Roodbergen and Vis 2009, Gagliardi, Renaud, and Ruiz 2012). Roodbergen and Vis (2009) give an overview over different applications of automated storage and retrieval systems (AS/RS) and also a possibility to identify different types of

automated storages. This classification lacks of a classification for the system regarded in this study due to several reasons.

One aspect differing greatly from most studies about automated storages is the retrieval policy. As the saw processes high amounts of the same assortment at once, it is obsolete to evaluate trip times of the retrieving device. The retrieval policy therefore has no impact on the time of commissioning but high impact on the stock development and as a consequence the needed storage size.

Another reason is that there are several challenges regarding the handling of logs, which include the necessity to store very high amounts of logs belonging to different assortments.

The classification fitting best was found in the work of Gudehus (2012). Thereof, the regarded system can be classified as a sorting storage with flow lanes.

Whereas sorting storages are quite common for handling sawn timber in sawmills, applications for logs were not proposed yet, to the best of our knowledge. Another challenge from a technical point of view is that the components of the automated storage have to be highly robust to be suitable for the mechanically demanding usage of storing logs and stacking the logs to stable piles.

The goal of this study is to find an appropriate dimension for an automated log yard for an existing sawmill through the simulation of several scenarios concerning different amounts of raw material and retrieval policies.

The following sections describe the available data from the regarded sawmill, the relevant attributes of the automated storage and the simulation model which was built to find a reasonable dimensioning for the automated log yard.

2 MATERIAL AND METHODS

The material for this study consists of the sawmill data - divided in data from the sorting station and data from the sawing process - and data about the automated storage.

After a short description of the possibilities of the analytical approach of the storage dimensioning problem, the main method of this study - the simulation model - is described in detail.

2.1 Sawmill Data

The relevant data from the sawmill mainly consists of the data from the sorting station and the data from the saw which are described in detail in the following.

The available data from the sorting station of the sawmill includes the date and time of the arrival of each sorted log, its length and diameter, its quality, and its assignment to a certain roundwood assortment. The evaluation of this data allows the definition of a very exact time-dependent distribution of the delivered raw material and its classification in the existing roundwood assortments. The number of assortments and their contribution to the total delivered volume are shown in figure 2.

The data about the sawing process, which is generated at the entrance of the saw, includes the date and time of processing, the length and the diameter of each log. It does not include the quality or the assignment to a certain assortments. As some assortments contain logs with the same diameters it is not possible to exactly identify the logs and define the sawn assortments. This lack of data allows only the recreation of probability distributions for sawn diameters. In contrast, the generation of an exact chronological sequence and probability distributions for the actually sawn assortments is not possible. Figure 3 shows the diameters of every sawn log for the time period of five months. It also depicts the diameter sequence for the saw derived from that data. Due to the high variability of the measurements, the calculation of a representative chronological diameter sequence required high attention.

There are two different ways of imitating the sawing process as close to reality as possible: One way is to strictly follow the chronological diameter sequence regarding the order of diameters and the amount of logs. From all assortments with a fitting diameter one assortment is chosen randomly. This way of log

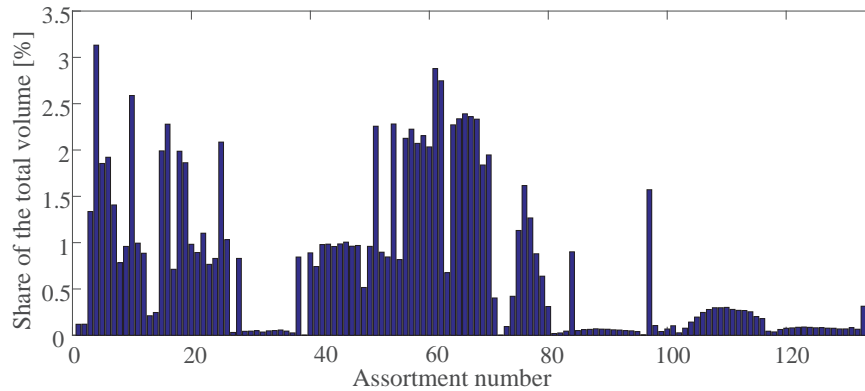

Figure 2: The shares of the total delivered volume of the roundwood assortments.

selection strategy will be addressed as selection strategy 4 in section 2.4.2. The second way (addressed as selection strategy 5 in section 2.4.2) is to choose the diameters according to the diameter probability distribution. As the probability function is defined as a continuous function, any value can be assigned to the diameter. The assortment with the diameter closest to the required one is selected. The amount is determined through a separate probability distribution depicting the sawn amounts of raw material.

2.2 Attributes of the Automated Storage

The concept of the automated log yard contains three main processes: filling, storing and emptying of the ASCs. Whereas the storing is a very long-lasting but a relatively simple process from a technical point of view, the filling and the retrieving process are short in duration but quite complex and technically challenging. All processes are defined by the ASC attributes and the properties of the log retrieving device which are described in the following section.

Each ASC consists of a filling device on the front end and two parallel conveyors which store the logs and transport them towards the back end where the taker can take and send them to the saw. The purpose of the filling device is to stack the logs to a stable pile. This is crucial for the stability of the pile. As space is costly and also limited it is also an issue to ensure space-efficient stacking. The height of the pile is therefore dependent on the filling device. The length of the ASC is defined by conveyors and was fixed to a unique standard length for this study. The width of the ASCs can differ as well and necessarily takes into account the lengths of the stored logs. The length categories at the regarded sawmill are three, four and five meters. It is possible to store logs in an ASC that are up to one meter shorter than the width of the ASC. Naturally the assignment of shorter logs to an ASC leads to a waste of space and capacity. For the regarded purpose two different widths are required and therefore, there are two kinds of ASCs. Another factor for the calculation of the capacity is the diameter-dependent fill factor. As logs with different diameters can be packed in geometrically differently dense stacks the log diameter has to be taken into account for this calculation. As a consequence the storage capacity of an ASC might change when a different assortment is assigned.

In figure 1 the moving directions of the log retrieving device are indicated through the gray arrows pointing up and down. It is therefore limited to a bidirectional movement with a certain speed. Since the taker can empty ASCs at both sides it is able to empty two opposite rows of ASCs. If two opposite ASCs contain the same assortment of logs, the taker can operate double-sided. In that case logs are taken from both ASCs alternately which increases the speed of the emptying-process. During the process of emptying an ASC can not be filled with new logs until the fill level of the ASC sinks beneath a certain fill level. Clearly, the productivity of the system must ensure a continuous production at the saw line.

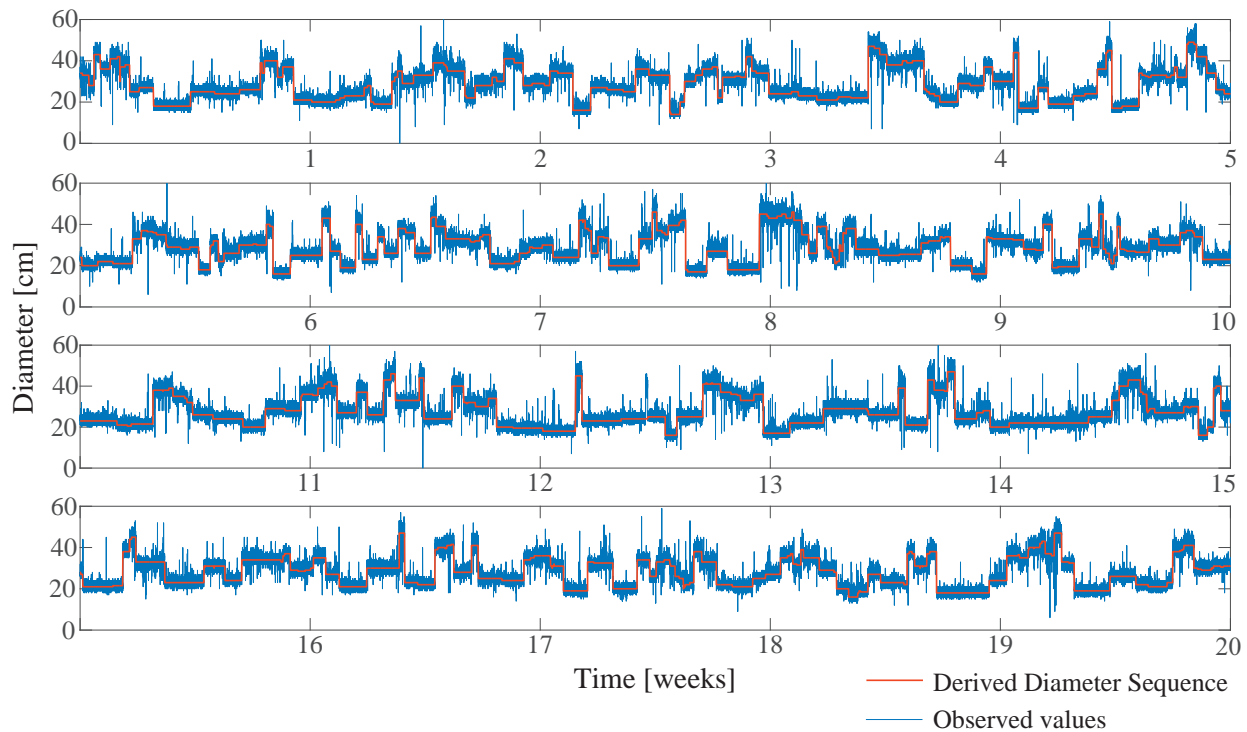

Figure 3: The diameters of the actually sawn logs and the derived diameter sequence.

2.3 The Analytical Approach

The reasonable dimensioning of storages and buffer storages is a very common problem (Arnold and Furmans 2009; Tompkins et al. 2010; Gudehus 2012) which can be solved analytically in many cases. As the assignment of the assortments to the ASCs is not fixed and the assortments have to be stored separately, the automated log yard can be characterized as a dynamic storage with a sorting function. The availability of two different types of ASCs makes the storage heterogeneous. The analytical calculation of appropriate storage dimensions requires an average and a highest amount for each stored assortment. The stock levels for each assortment are not defined and result from the sorting data and the raw material consumption of the sawing process, which is dependent on the log selection strategy. Therefore, the analytical approach is not sufficient and a simulation model, capable of depicting those dependencies, is required to reliably assess the appropriate storage capacity. However, the minimum required number of ASCs for a certain scenario can be calculated as shown in equation 1, where stock means the total amount of roundwood which has to be stored in the automated log yard

$$\text{minimum number of ASCs} = \frac{\text{stock}}{\text{ASC Capacity}}. \quad (1)$$

The ASC Capacity means the storage capacity of the ASC. As it is calculated through the volume of the ASC times an assortment-dependent filling factor, the capacity can vary. For this calculation the average filling factor from all assortments was taken.

The minimum number of required ASCs for the scenario with the least amount of raw material is used as a basic value, further called base, in the results section (section 3).

2.4 The Simulation Model

An overview of the functional principle of the simulation model is given in figure 4. The discrete event simulation model was built with the simulation software AnyLogic (Professional, version 7.3.6). The logs are created according to the real data distributions of the sorting station of the regarded sawmill. The crucial data in that part of the model is the arrival rates of the logs and the assignment to the different roundwood assortments. When the logs are assigned to an assortment they are conveyed to the appropriate ASC and stored in the automated log yard. The ASCs, but also the storing and the taking events underlie certain physical and technical constraints, termed "Storage System data" in figure 4, which have to be taken into account. When logs are needed for sawing, they are taken from the ASCs and conveyed to the saw. Beside influencing the speed of the sawing process, which is depending on the log diameter, the sawing data also determines the selection of the assortments which are sawn in some scenarios. For the testing of different circumstances several parameters were defined as a model input. The parameters and the crucial logic behind the simulation model are described in the following sections.

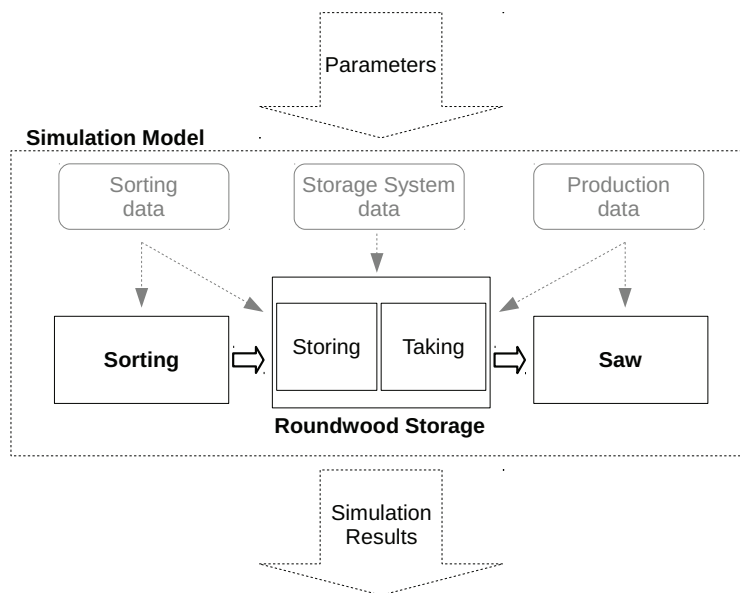

Figure 4: The overview of the simulation model.

2.4.1 Creation and Selection of the Storage Components

The goal of the simulation model is to find an appropriate dimension of the automated log yard to cope with real-life log yard requirements. Therefore, the logic shown in figure 5 was created. After the arrival of the logs they are assigned to a certain roundwood assortment. Then it is checked whether an ASC is already assigned to that assortment or not. If an ASC is assigned, has still capacity and is ready for further filling, the log is transported to and stored into that ASC. An ASC is not ready for further filling until its fill level sinks below a certain percentage when it is currently emptied.

If that ASC is full or not ready for further filling the opposite ASC is checked. If it is free it is assigned to that assortment and the log is stored into that ASC. If the opposite ASC is occupied or the assortment is not assigned to an ASC yet, a free ASC is searched and assigned. An ASC with a free opposite ASC is preferred in that case. If no free ASC is available but needed, a new ASC is created and assigned to the current assortment. Therefore, the automated storage grows until it is able to store the full amount of logs which are delivered. Since the ASCs are created when needed and remain even if they are not needed

any more, the result is the required number of ASCs to provide enough storage capacity over the regarded time period.

When an ASC is fully emptied, the assignment to the assortment is deleted and it is available for a new one. Every time a further ASC is required, two ASCs of the same size are created to ensure a symmetrical layout of the automated storage to allow exact opposite ASCs. This is necessary to enable double-sided taking when two opposite ASCs are assigned to the same assortment. Both opposite ASCs can be emptied simultaneously and the transport rate from the storage to the saw can be increased in that case. The logic in figure 5 seeks to achieve a high number of two opposite ASCs assigned to the same assortment and consequently increases the possibility of double-sided taking.

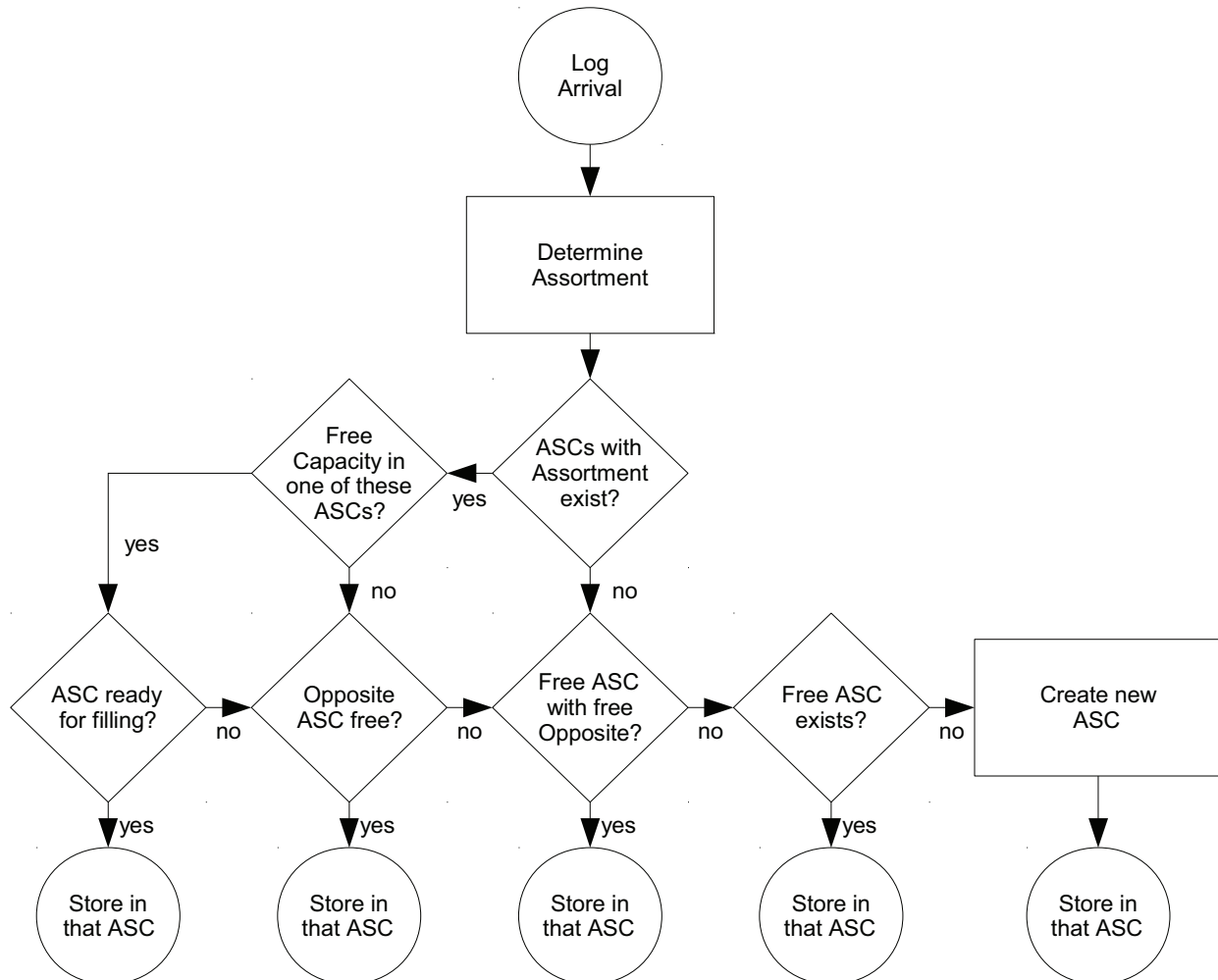

Figure 5: The logic of choosing and creating automated storage components (ASCs).

2.4.2 Model Input - Parameters

The parameter initial stock depicts the assumed average stock level in the roundwood storage. As the input into the storage and the taking from the storage are defined through the probability distribution of delivered raw material and the raw material consumption of the saw, the stock can vary greatly. However, the initial stock has a high impact on the average stock level.

The mix of roundwood delivered to the saw is very diverse and the logs are sorted in a high number of roundwood assortments. A small portion of these assortments are not processed on the saw but used otherwise. Therefore, it is not necessary to store them in the automated storage. Furthermore, it is assumed that assortments that are delivered and consequently sawn very infrequently, unnecessarily block ASCs and increase the size of the automated storage. To avoid these effects the possibility of by-passing the automated storage should be kept in mind. To depict this possibility, the infrequently delivered assortments can be not considered for the automated storage. This parameter is expressed through a percentage which is consisting of the quantitatively most important assortments. A percentage of 85% therefore means that only the quantitatively most important assortments, which contribute to 85 % of the total amount of raw material, are considered.

Due to the different structures of the collected data at the saw and the data of the sorting station, it is not possible to clearly identify the logs and the assortments at the saw. The discrepancy concerning data structure only allows a rough recreation of the actual sawing strategy. Therefore, in order to imitate the sawing process, a parameter controlling the different logics for selecting logs for the sawing process was implemented. These five raw material selection strategies are:

1. The ASC with the highest fill level is emptied first.
2. The assortment with the highest total stock is sawn first.
3. Random Selection of ASCs.
4. The assortments are chosen based on the rough recreation of the actual sawing strategy. The order of the assortments and the sawn amount strictly follows that recreation.
5. The roundwood selection and the sawn amounts follow probability functions derived from the actual sawing strategy.

2.4.3 Verification and Validation of the Model

As the model input is based on real sawmill data the several parts of the model could be verified through comparing the model outcome with the real data. The first part in the model is the incoming roundwood which has to fit the real data in terms of amounts per time, dimension and assigned assortment. Furthermore, the needed space for certain amounts of different assortments in the ASCs and their generation when needed was verified through comparison with manual calculations.

The verification of the third part, the retrieval of logs for the sawing process, was again done through comparing the model data with real data from the sawing process. As the possibilities concerning raw material selection are not only depending on the real data but also on the current stock levels and the retrieval policy, differences to the real data can occur. To meet that problem different roundwood selection strategies were implemented to get an idea of the effects of that crucial part of the model.

As there is no existing comparable system, it is not possible to validate the model through comparing the model results to real data in terms of storage dimension. The only value which can be compared to the existing sawmill data is the development of the stock level. As the automated storage has to store the same amounts of raw material and should not have any impact on the stock levels, the comparison of this value can be used for validation.

Further validation was done through simulating extreme scenarios. Those scenarios covered extreme values of amounts of delivered raw material and extreme values of sawing capacity. The model reacted plausibly to the extreme scenarios on both side of the automated storage, material delivery and material retrieval.

2.4.4 Simulation Study

Table 1 shows the values of two changing model parameters: initial stock and considered roundwood assortments. Although the stock at the log yard varies greatly, it is crucial to define an initial stock. The base for the initial stock was set to the average stock over the regarded time period and by way of comparison

the model was also tested for an initial stock of 75% of the average stock. As not all assortments are actually sawn but used otherwise, some of them do not need to be stored in the automated storage. As those assortments are not precisely defined, the amount of assortments which have to be stored is expressed through a percentage of the amount of roundwood. Table 1 shows that four values for that parameter were tested: 85%, 90%, 95% and 100%.

To assess the stability of the results when different ways of raw material selection are applied, the five roundwood selection strategies, which are explained above, were tested for all scenarios defined in table 1.

The variation of those three parameters leads to a total of 40 different scenarios. The scenarios were run for four simulated weeks with 25 replications each. The simulation horizon of four weeks seems suitable, because the time is sufficient to observe the system behavior closely on the one hand. On the other hand a longer simulation horizon could cause problems due to the different data qualities of the sorting and sawing data. As the sawn logs cannot clearly be identified and only a certain percentage of assortments is considered for production, the stock level can tendentially rise or fall. The stability of the stock level can be determined also in four simulated months, but a higher simulation horizon could distort the results due to that reason.

To meet the requirements for a high level of activity in the storage, the data from a month with high raw material delivery amounts was taken.

Table 1: The parameter ranges for the different scenarios.

	min	max	step
Initial Stock [%]	75	100	25
Considered Assortments [%]	85	100	5

2.4.5 Model Output - Simulation Results

The most important model output is the number of ASCs that are needed under certain circumstances. As there are different kinds of ASCs, there is a total number of ASCs and also a number for the two different widths of ASCs. The results are only shown for the total number. To allow the documentation of the growth of the automated storage the total stock is tracked as well. These output numbers allow the estimation of a necessary size of the automated storage for different stocks and scenarios. The number of required ASCs is set in relation to a base value and expressed in a percentage of this base calculated in section 2.3. That base is the theoretically minimal number of ASCs for the smallest amount of raw material stored in the automated storage.

3 RESULTS AND DISCUSSION

Figure 6 shows the required number of ASCs for the five different roundwood selection strategies and the four different percentages of assortments stored in the automated storage for an initial stock of 75%. As the base is the theoretical minimum for the required number of ASCs, it is clear that this number cannot be reached. The base number of ASCs could only be achieved, if every ASC is filled completely. This is practically impossible due to the number of different assortments. Even the scenarios with the least amount of raw material, which are the first five scenarios in figure 6 require 10% to 20% more ASCs than theoretically necessary. If the percentage of considered assortments is increased, the number of required ASCs increases dramatically. When 100% of the assortments are considered, the number of required ASCs varies between 150% and even more than 200%. That can be explained through the fact that all assortments - even the quantitatively smallest - need to be stored separately. Therefore, each assortment needs an own ASC. Even if the amount of the stored assortment is just a few logs, the ASC is locked for other assortments and capacity is wasted. As there are also great variations within the same percentages of considered assortments, it can be assumed, that the raw material selection strategy also has a great impact

on the size of the required automated storage. Thus, a wrong log selection strategy can lead to a very inefficient usage of the available storage.

Figure 7 shows the required number of ASCs for all scenarios for an initial stock of 100%. As more logs have to be stored, the minimum required number of ASCs for 100% initial stock is about 150% of the base value. The effect of a dramatically increased number of ASCs with an increasing percentage of considered assortments is even stronger with a higher stock. The difference between the different roundwood selection strategies is also intensified compared to a lower stock level. Although the scenarios with 100% initial stock and 100% considered assortments have to deal with 156% of the amount of raw material compared to the amount of the base value (calculated through equation 2), those two effects lead to a greatly increased number of required ASCs, lying at about 200% to 250% of the base value

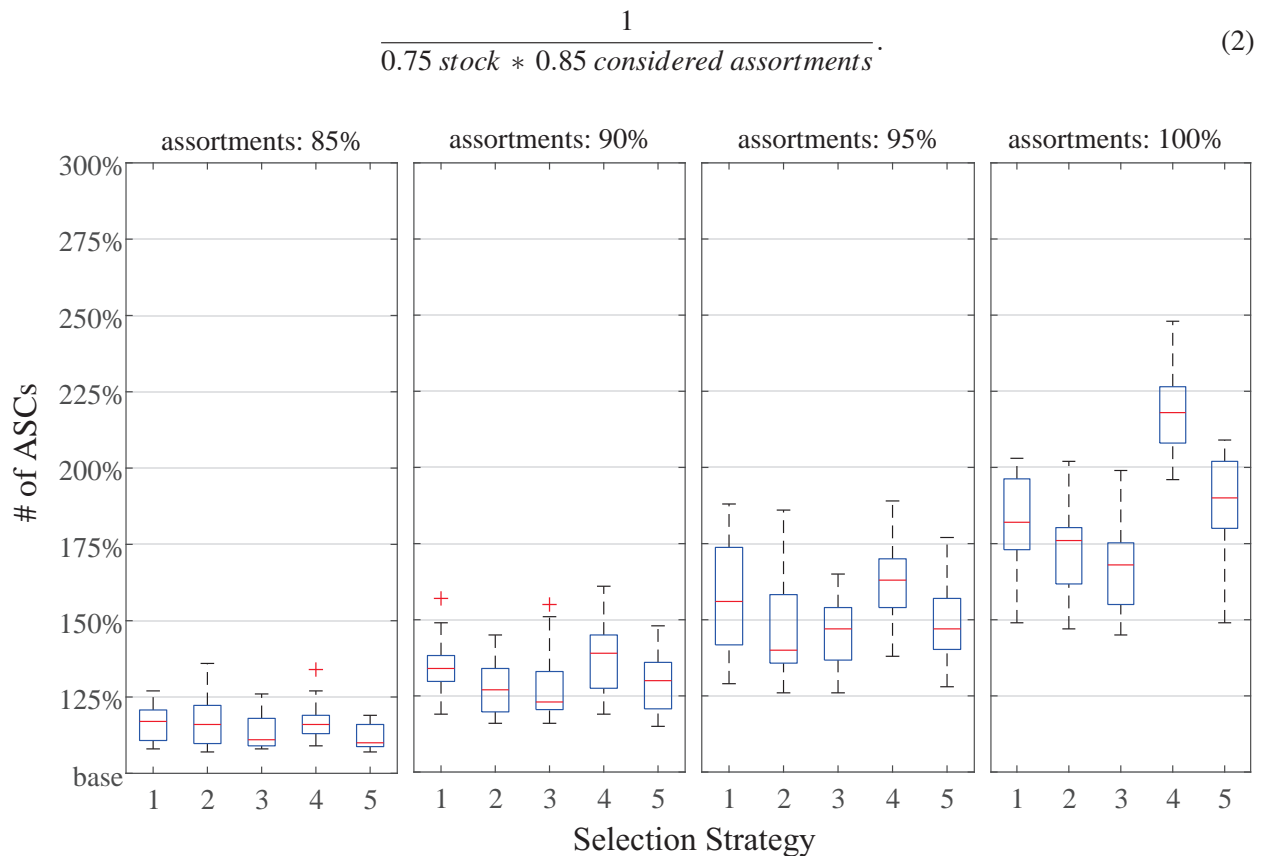

Figure 6: The required total number of ASCs for the five raw material selection strategies and different amounts of considered assortments for 75% initial stock.

The great impact of the percentage of considered assortments, caused by their highly different quantitative importance, inevitably leads to the predicted question for the possibility of a by-pass of the automated storage. Such a by-pass may be of great advantage concerning the size and the utilization of the automated storage. The obvious disadvantage is the necessity of dealing with the by-passed assortments, which are probably transported conventionally with a loader. If the amount of by-passed logs increases too much, it might erase the positive effects of the automated storage. Thus, the amount of logs stored automatically needs a careful investigation.

An adaption of the ASC lengths may mitigate that problem and should be further investigated. Due to constructional reasons it will not be possible to use ASCs of different lengths in one storage. Therefore, a reasonable unique length has to be defined.

Since the results show that the raw material selection strategy can also have a great impact on the size of the automated storage further effort should be put in developing a strategy which minimizes the required storage capacity but also meets the demands from the sawing process. The final step to the realization of the automated log yard requires the transcription of the calculated storage dimensions and the possibilities of by-passing to a practical layout which necessarily has to be applicable to the existing circumstances.

Further studies should focus on the comparison of the automated system to current log yard operations. To enable reasonable investment decisions the investment costs, the area used, the number of loaders and the overall operating costs of the different log yard handling systems have to be evaluated.

Another interesting issue for further investigations is the observation of the average fill level or utilization of the automated storage. In combination with an optimization of the dimensions of the ASCs and improved roundwood selection strategies, the size of the automated log yard could be even better adapted to the storage requirements.

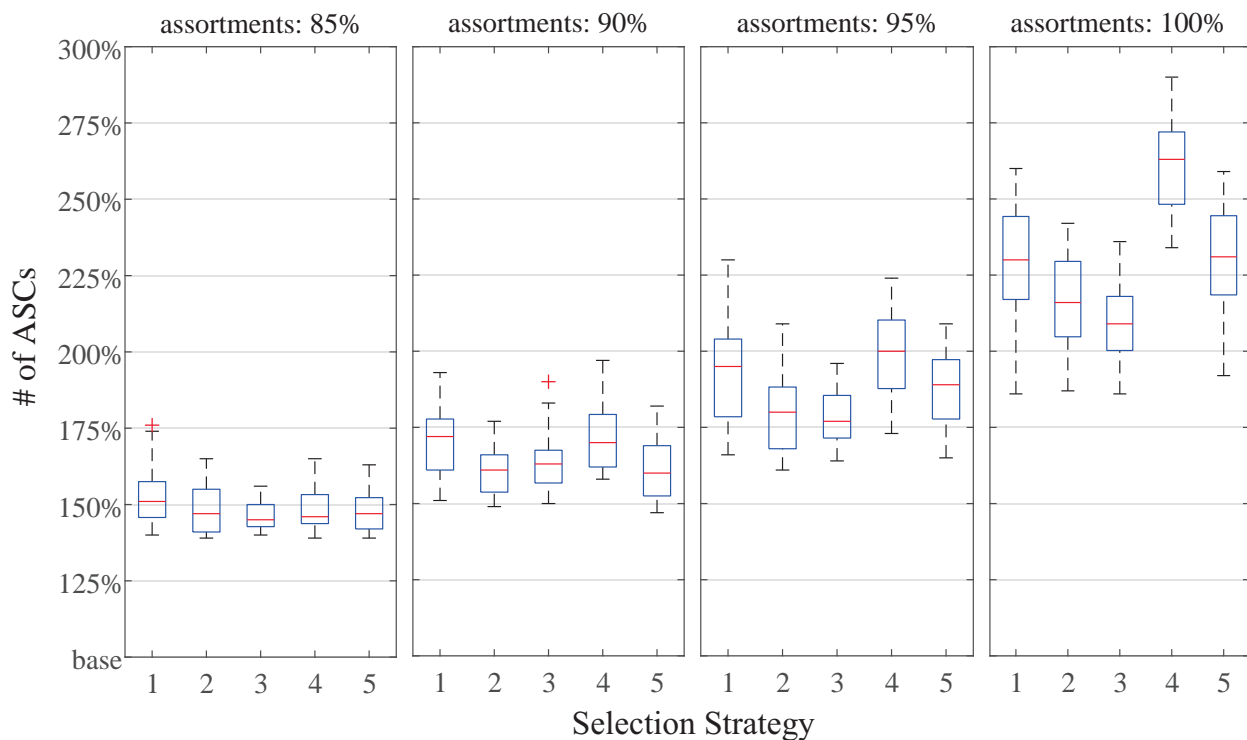

Figure 7: The required total number of ASCs for the five raw material selection strategies and different amounts of considered assortments for 100% initial stock.

4 CONCLUSION

This study investigates the possibility of the automation of a sawmill log yard. Data of an actual sawmill and the technical data of newly developed automated storage components (ASCs) were combined and integrated into a simulation model. With the simulation of 40 scenarios, varying in the number of roundwood assortments, initial stocks and raw material selection strategies, the log yard was tested under different circumstances. The results show the required dimensioning of the automated log storage, expressed in the required number of ASCs, for each scenario. The preliminary results show the huge effects of small parameter changes and underline the importance of the careful investigation and definition of storing and selection strategies for defining the size of an automated log storage.

The study gives an example for the use of a simulation model to find a reasonable dimensioning of an automated storage under different circumstances considering high amounts of data.

The simulation model can further be used to study other log yards and propose appropriately dimensioned automated storages taking into account the processed volumes and the variations and distributions of the raw material assortments. Consequently the managerial decision whether the system is suitable for the sawmill or not is supported.

REFERENCES

- Arnold, D., and K. Furmans. 2009. *Materialfluss In Logistiksystemen*. 9 ed. Berlin: Springer.
- Beaudoin, D., L. LeBel, and M. A. Soussi. 2012. “Discrete Event Simulation To Improve Log Yard Operations”. *Infor* 50 (4): 175–185.
- Gagliardi, J.-P., J. Renaud, and A. Ruiz. 2012. “Models For Automated Storage And Retrieval Systems: A Literature Review”. *International Journal of Production Research* 50 (24): 7110–7125.
- Gudehus, T. 2012. *Logistik 2*. 4 ed. Berlin: Springer.
- Rathke, J., M. A. Huka, and M. Gronalt. 2013. “The Box Assignment Problem In Log Yards”. *Silva Fennica* 47 (3).
- Roodbergen, K., and I. Vis. 2009. “A Survey Of Literature On Automated Storage And Retrieval Systems”. *European Journal of Operational Research* 194 (2): 343–362.
- Tompkins, J., J. White, Y. Bozer, and J. Tanchoco. 2010. *Facilities Planning*. 4 ed. New York: Wiley.

AUTHOR BIOGRAPHIES

MARTIN PERNKOPF is working on his Ph.D. studies as a researcher at the Institute of Production and Logistics of the University of Natural Resources and Life Sciences Vienna (Austria). He finished his Master Studies of Wood Technology and Management at this university in 2015. His research interests include discrete-event and agent-based simulations and their combination applied in logistic issues or issues of production process improvements mainly in the wood industry sector. His email address is martin.pernkopf@boku.ac.at.

MANFRED GRONALT is Full Professor of business economics and business economics in the wood industry at the Institute of Production and Logistics of the University of Natural Resources and Life Sciences Vienna (Austria). As the head of this institute his research interests include the application of simulation and optimization techniques in the fields of wood industry, healthcare, and railway and multi-modal logistic networks. His email address is manfred.gronalt@boku.ac.at.